

TA-F6B

US Model
Canadian Model
AEP Model
UK Model
E Model



INTEGRATED STEREO AMPLIFIER

SPECIFICATIONS

GENERAL

Power Requirements:	120 V ac, 60 Hz (US, Canadian model) 110 – 120 V and 220 – 240 V ac, adjustable 50/60 Hz (AEP, UK, E model)
Power Consumption:	190 W (US model) 490 VA (Canadian model) 450 W (AEP, E model) 550 W (UK model)
Dimensions:	Approx. 430 (w) x 170 (h) x 390 (d) mm 16 $\frac{7}{8}$ (w) x 6 $\frac{3}{4}$ (h) x 15 $\frac{3}{8}$ (d) inches including projecting parts and controls
Weight:	Approx. 12.5 kg, 27 lb 9 oz (net) Approx. 14.2 kg, 31 lb 5 oz (in shipping carton)

SAFETY-RELATED COMPONENT WARNING!!

COMPONENTS IDENTIFIED BY SHADING AND  MARK ON THE SCHEMATIC DIAGRAMS, EXPLODED VIEWS AND IN THE PARTS LIST ARE CRITICAL TO SAFE OPERATION. REPLACE THESE COMPONENTS WITH SONY PARTS WHOSE PART NUMBERS APPEAR AS SHOWN IN THIS MANUAL OR IN SUPPLEMENTS PUBLISHED BY SONY.

ATTENTION AU COMPOSANT AYANT RAPPORT
À LA SÉCURITÉ !

LES COMPOSANTS IDENTIFIÉS PAR UN TRAMÉ ET UNE MARQUE  SUR LES DIAGRAMMES SCHEMATIQUES, LES VUES EXPLOSÉES ET LA LISTE DES PIÈCES SONT CRITIQUES POUR LA SÉCURITÉ DE FONCTIONNEMENT. NE REMPLACER CES COMPOSANTS QUE PAR DES PIÈCES SONY DONT LES NUMÉROS SONT DONNÉS DANS CE MANUEL OU DES SUPPLÉMENTS PUBLIÉS PAR SONY.

POWER AMPLIFIER SECTION

Power Output and Total Harmonic Distortion:	With 8 Ω loads, both channels driven, from 20–20,000 Hz; rated 100W per channel minimum RMS power, with no more than 0.03 % total harmonic distortion from 250 mW to rated output. (US, Canadian model)
Continuous RMS Power Output: (Less than 0.03 % THD, both channels driven simultaneously)	At 20 Hz–20 kHz 100 W + 100 W (8 Ω) According to DIN 45500 100 W + 100 W (8 Ω) (AEP, UK, E model)
Power Bandwidth (IHF):	5 Hz – 35 kHz (50W output, 0.03 % THD, 8 Ω) (AEP, UK, E model)
Harmonic Distortion:	Less than 0.03 % at rated output Less than 0.015 % at 1 W/10 W output
Intermodulation (IM) Distortion: (60 Hz : 7 kHz = 4 : 1)	Less than 0.03 % at rated output Less than 0.008 % at 1 W/10 W output
Frequency Response:	DC – 100 kHz $\begin{matrix} +0 \\ -1 \end{matrix}$ dB

– Continued on page 2 –

SONY[®]

SERVICE MANUAL

SECTION 3 ADJUSTMENTS

- Note:** 1. DC BIAS and DC BALANCE adjustments should be performed about several minutes later after the POWER switch (S10) is turned on.
2. Repeat DC BIAS and DC BALANCE adjustments two or three times.
3. After replacing the power transistors, DC BIAS and DC BALANCE adjustments should be performed.

DC Balance Adjustment

Procedure:

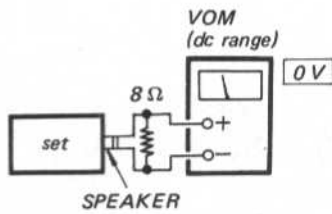

Adjust RT301 (L-CH) and RT351 (R-CH) for 0 V reading on the VOM.

Adjustment Location:

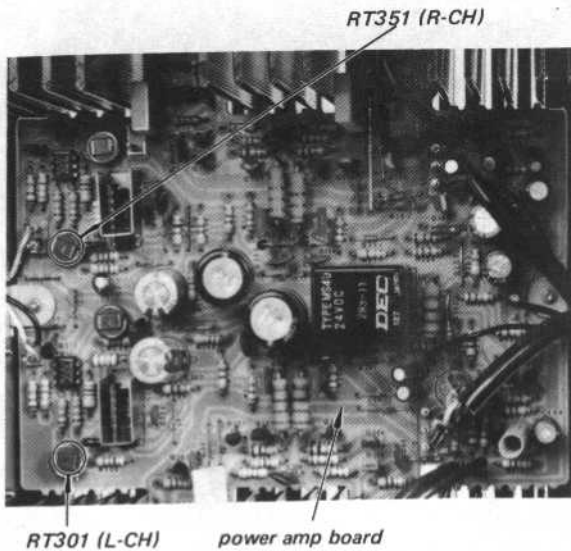

DC Voltage Adjustment

Procedure:

1. Connect a jumper wire.
2. Adjust RT601 for 98–99 V reading on the VOM.

Adjustment Location:

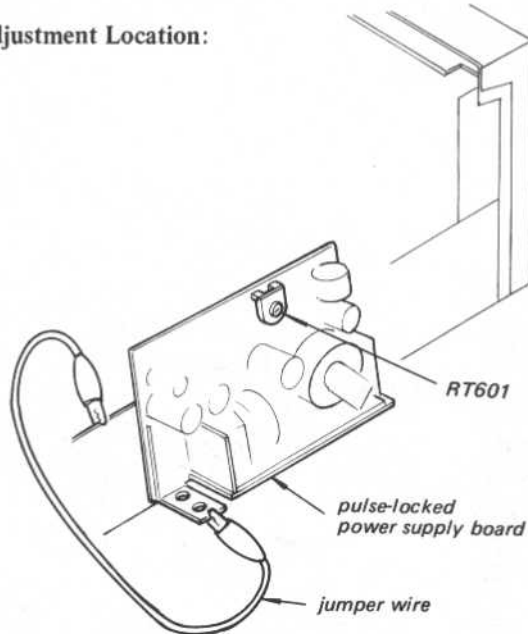

(US, Canadian model)

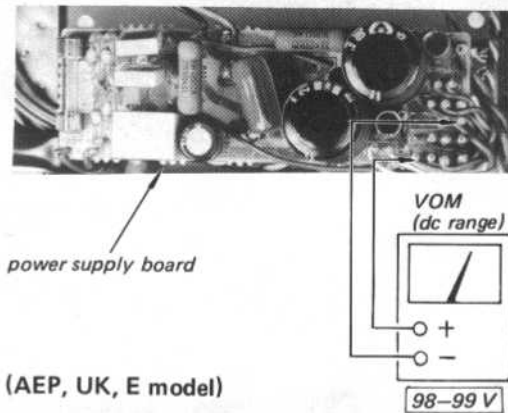

(AEP, UK, E model)

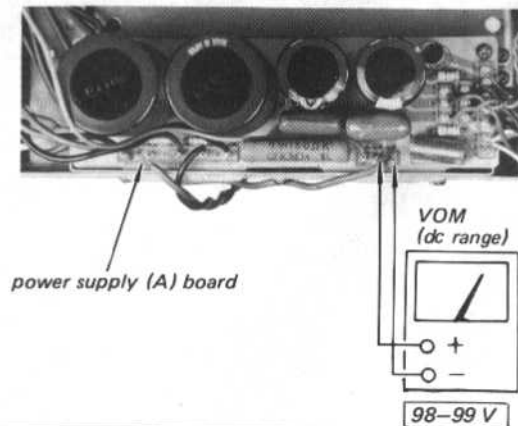

DC Bias Adjustment

Procedure:

Adjust RT302 (L-CH) and RT352 (R-CH) for 22 mV reading with no signal input.

Adjustment Location:

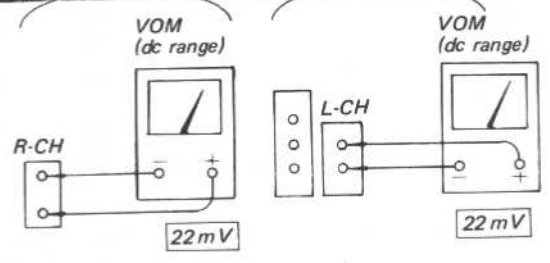
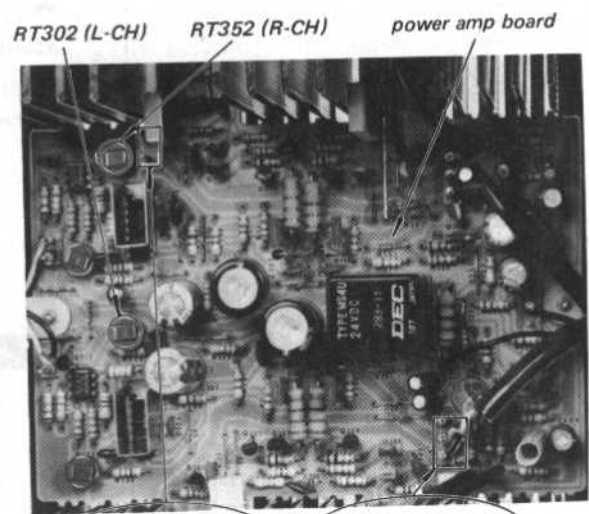

Meter Level Adjustment

Setting:

FUNCTION switch: TUNER

Procedure:

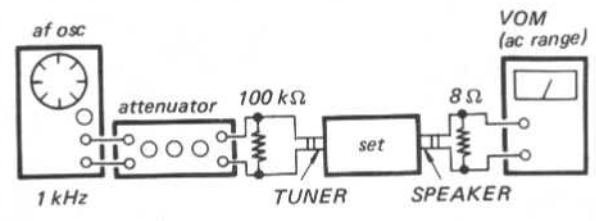

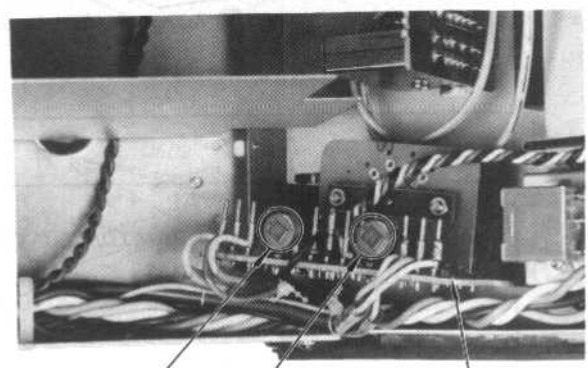

1. Turn the VOLUME control fully clockwise.
2. Adjust the TUNER input level for 2.83 V (1 W) reading on the VOM.
3. Adjust RT901 (L-CH) and RT951 (R-CH) so that the power meters indicate 1 W.

Adjustment Location:

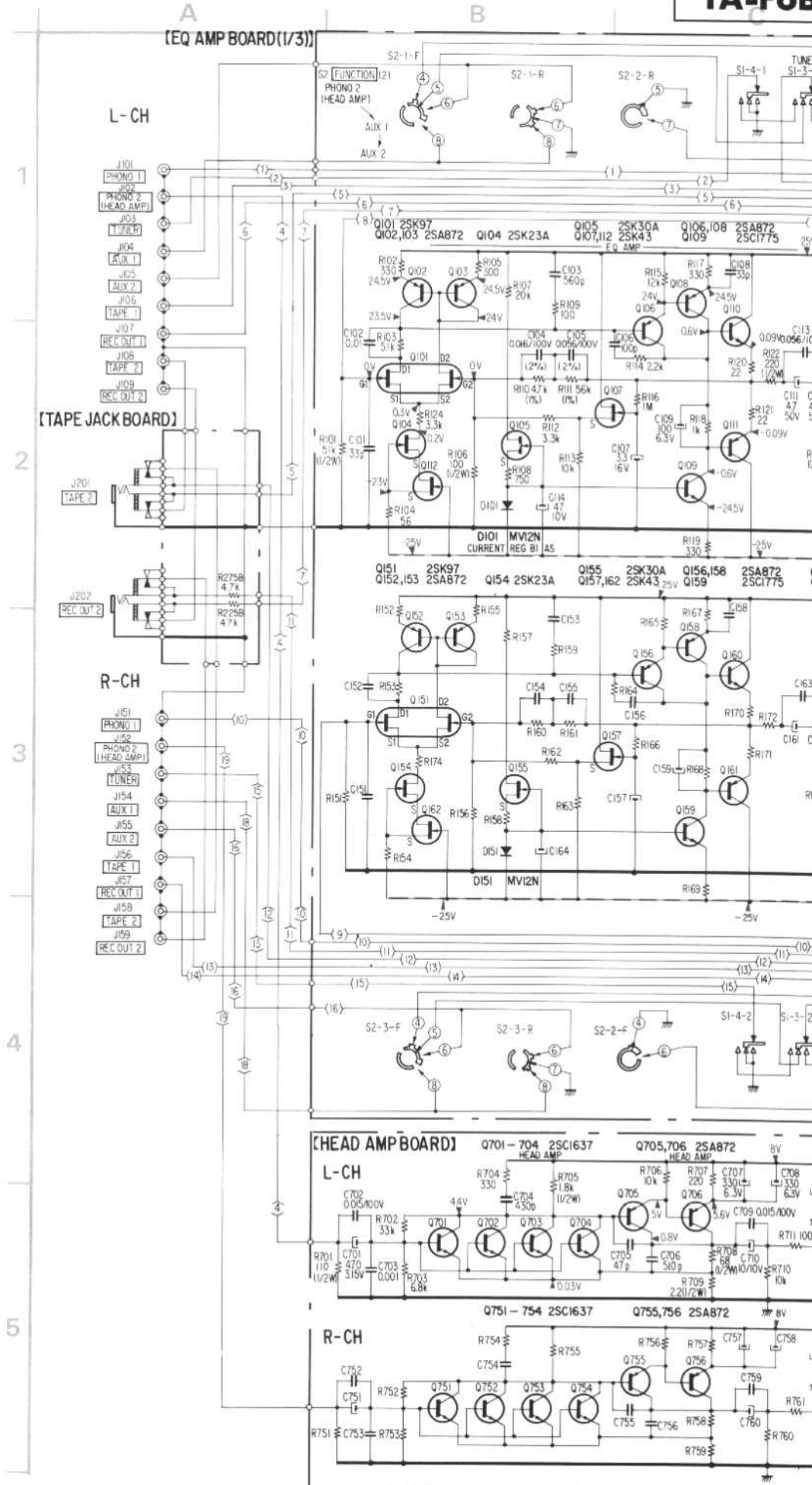

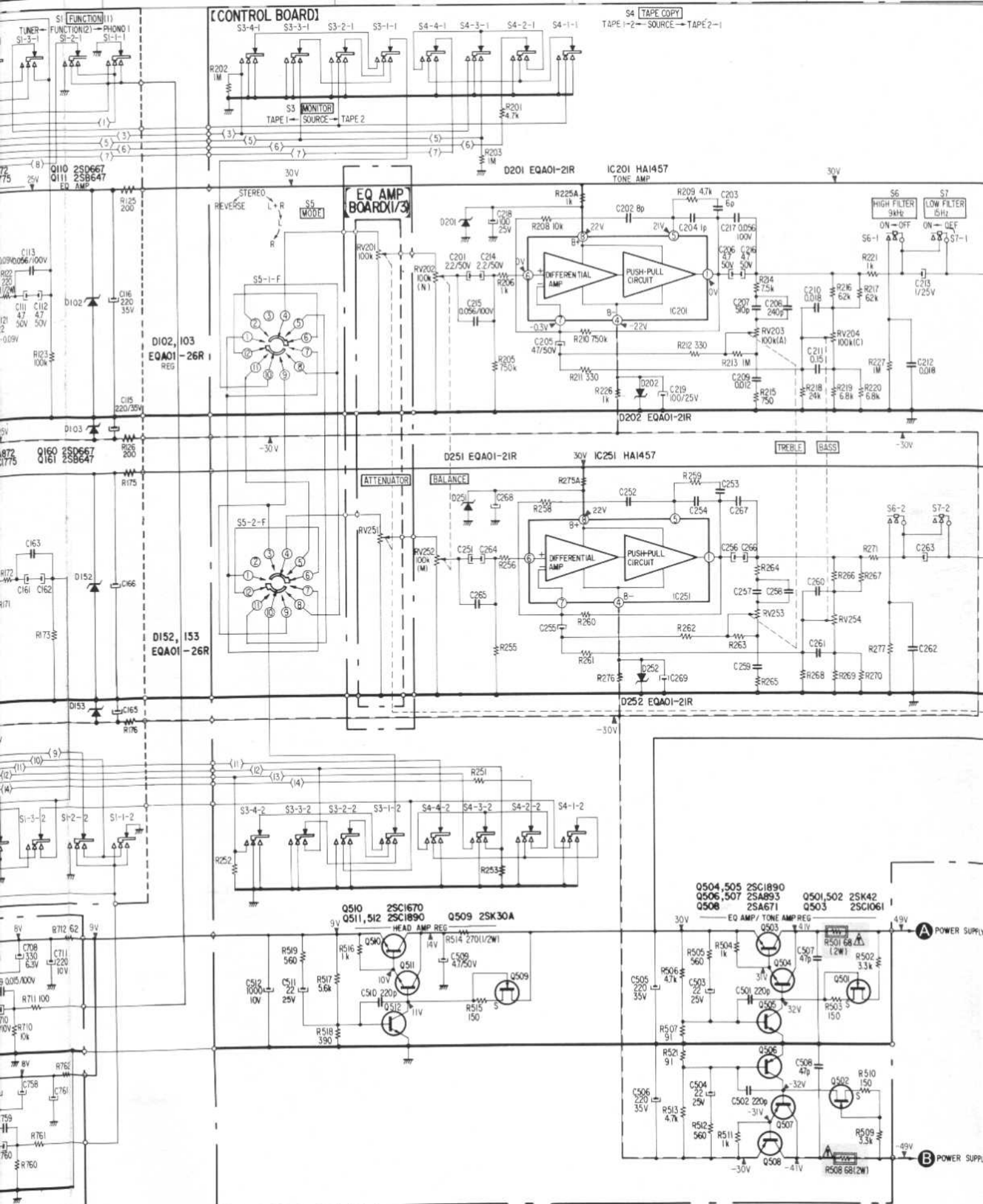





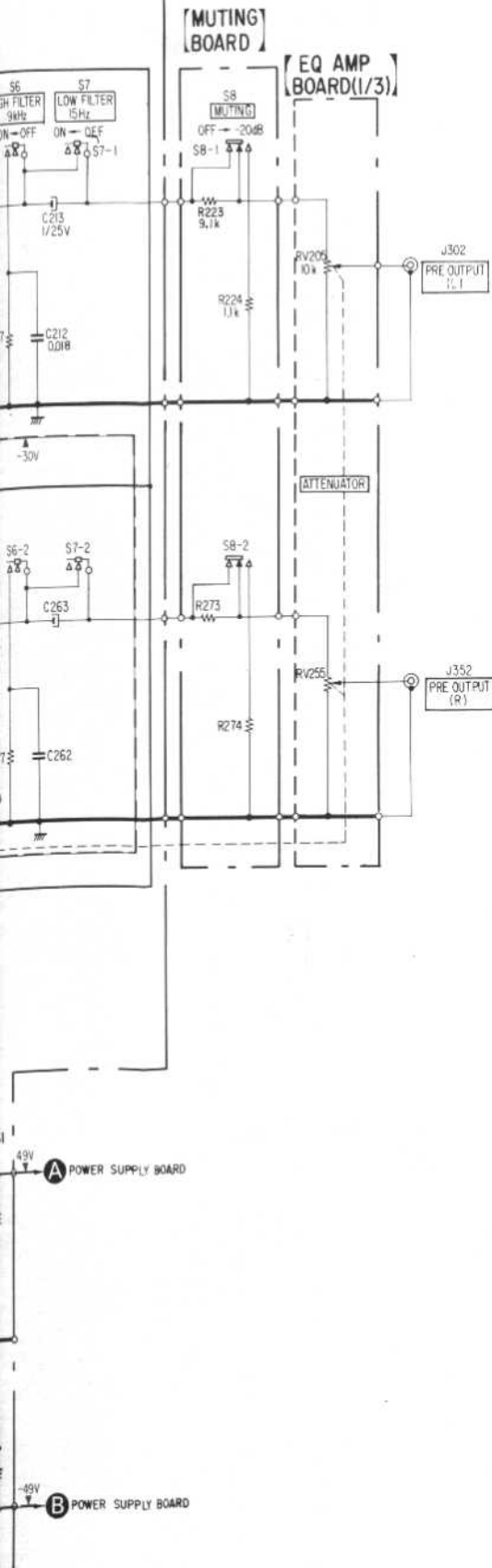

Note: The components identified by shading and mark  are critical for safety. Replace only with part number specified.

Note: Les composants identifiés par un tramé et une marque  sont critiques pour la sécurité. Ne les remplacer que par une pièce portant le numéro spécifié.



Note:

- Components for right channel have same values as for left channel. Reference numbers are coded from 151, 251 or 751.
- All capacitors are in μF unless otherwise noted. $\text{pF} = \mu\mu\text{F}$ 50 WV or less are not indicated except for electrolytics.
- All resistors are in ohms, $\frac{1}{4}\text{W}$ unless otherwise noted. $\text{k}\Omega = 1000 \Omega$, $\text{M}\Omega = 1000 \text{k}\Omega$
- All variable and adjustable resistors have characteristic curve B, unless otherwise noted.
-  : nonflammable resistor
- 1% or 2% indicates component tolerance.
-  : panel designation
-  : B+ bus.
-  : B- bus.
- Voltages are dc with respect to ground unless otherwise noted.
- Readings are taken under no signal conditions with a VOM (20 $\text{k}\Omega/\text{V}$).
- Voltage variations may be noted due to normal production tolerances.
- Switch

Ref. No.	Switch	Position
S1-1-1, 2 S1-2-1, 2 S1-3-1, 2 S1-4-1, 2	FUNCTION (1)	FUNCTION (2)
S2-1-F, R S2-2-F, R S2-3-F, R	FUNCTION (2)	PHONO 2 (HEAD AMP)
S3-1-1, 2 S3-2-1, 2 S3-3-1, 2 S3-4-1, 2	MONITOR	SOURCE
S4-1-1, 2 S4-2-1, 2 S4-3-1, 2 S4-4-1, 2	TAPE COPY	SOURCE
S5-1-F, 2-F	MODE	STEREO
S6-1, 2	HIGH FILTER 9 kHz	OFF
S7-1, 2	LOW FILTER 15 Hz	OFF
S8-1, 2	MUTING	OFF

4-7. POWER AMP SECTION SCHEMATIC DIAGRAM (AEP, UK, E model)

TA-F6

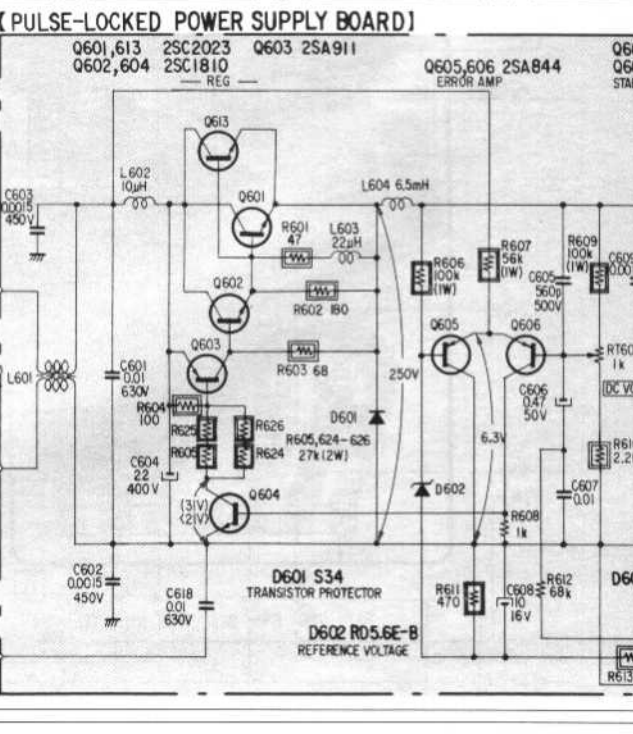
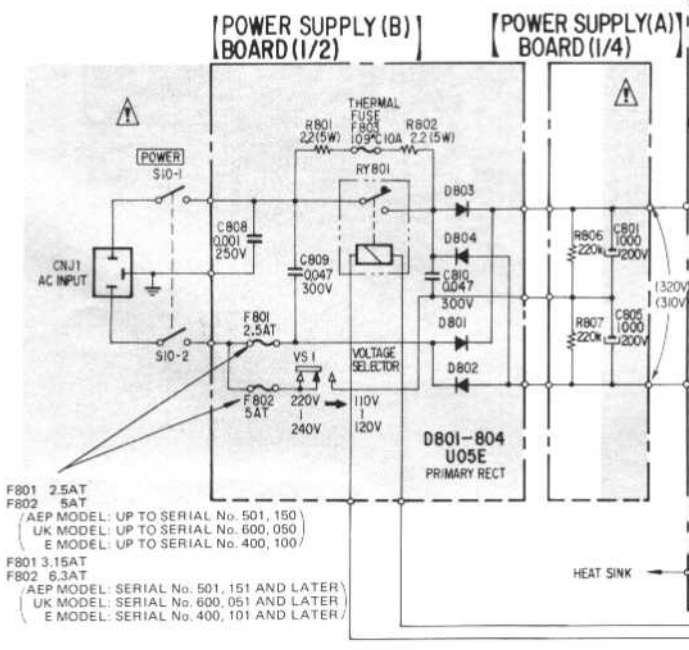
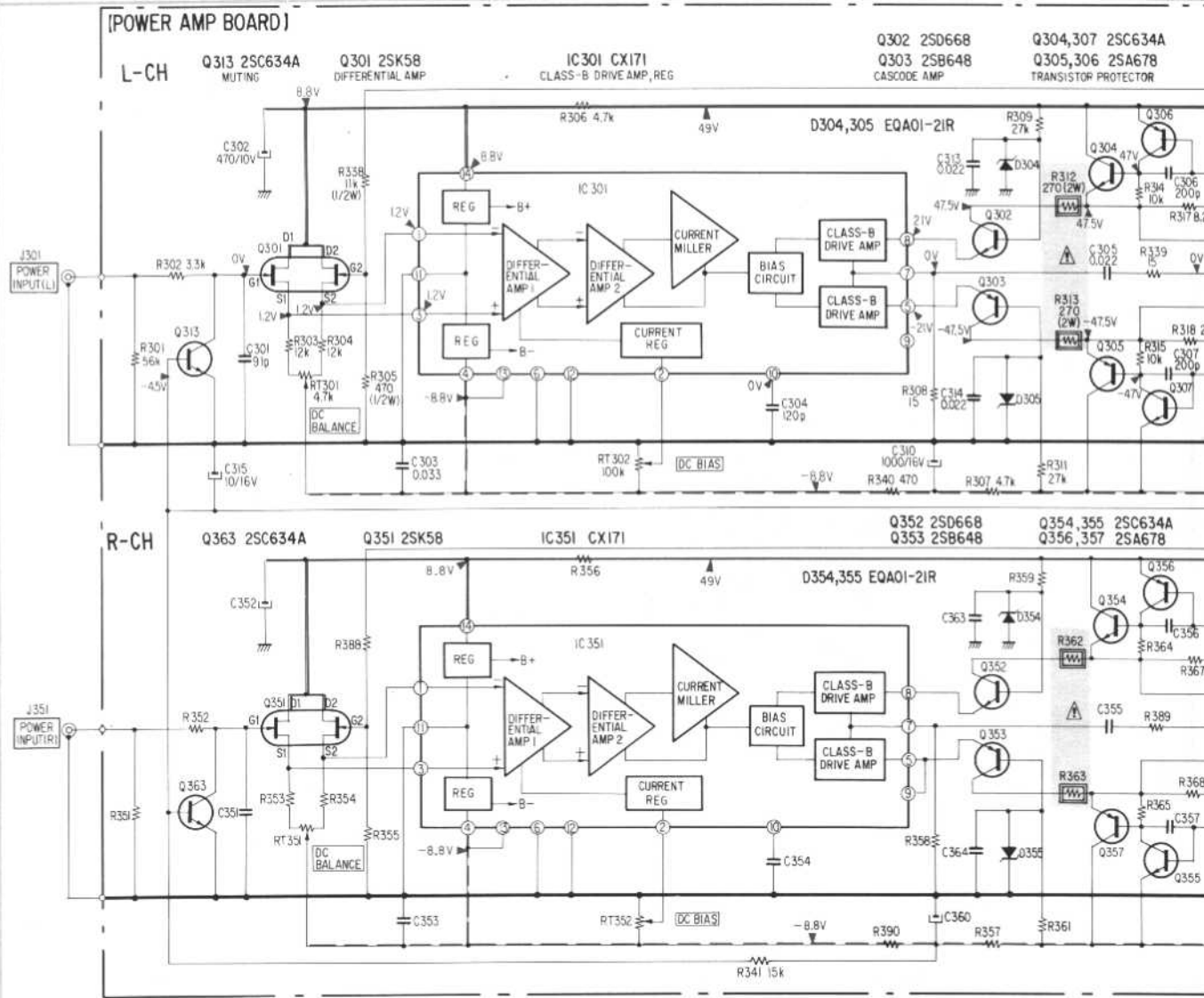

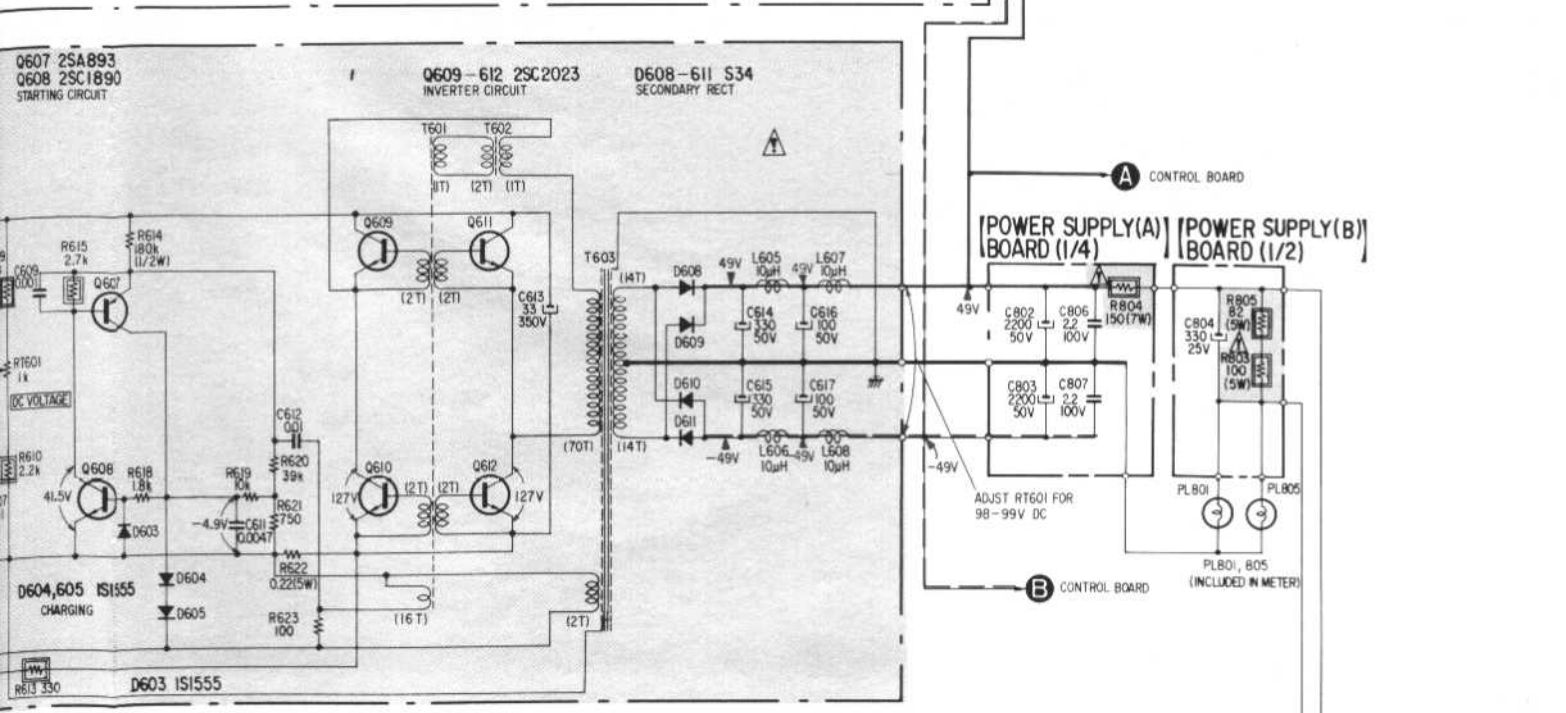
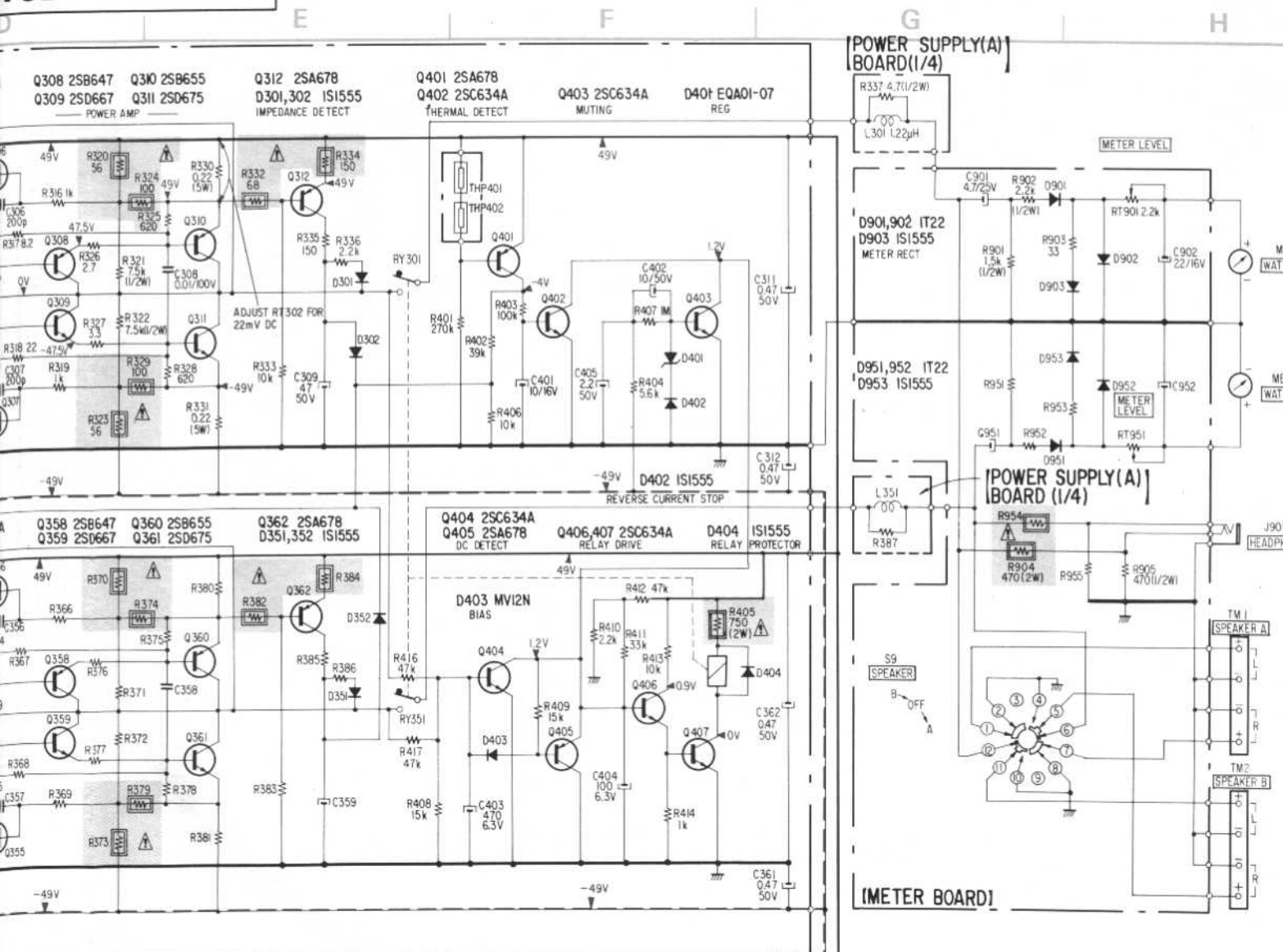







Note: The components identified by shading and mark  are critical for safety. Replace only with part number specified.

Note: Les composants identifiés par un trame et une marque  sont critiques pour la sécurité. Ne les remplacer que par une pièce portant le numéro spécifié.

Note:

- Components for right channel have same values as for left channel. Reference numbers are coded from 351 or 951.
- All capacitors are in μF unless otherwise noted. $\text{pF} = \mu\mu\text{F}$ 50 WV or less are not indicated except for electrolytics.
- All resistors are in ohms, $\frac{1}{4}\text{W}$ unless otherwise noted. $\text{k}\Omega = 1000 \Omega$, $\text{M}\Omega = 1000 \text{k}\Omega$
- All variable and adjustable resistors have characteristic curve B, unless otherwise noted.
-  : direct connection to points marked  on the chassis.
-  : nonflammable resistor.
-  : panel designation
-  : adjustment for repair.
-  : B+ bus.
-  : B- bus.
- Voltages are dc with respect to ground unless otherwise noted.
- Readings are taken under no signal conditions with a VOM (20 $\text{k}\Omega/\text{V}$).
() : 120 V AC input
< > : 240 V AC input
- Voltage variations may be noted due to normal production tolerances.
- Switch

Ref. No.	Switch	Position
S9	SPEAKER	B
S10-1, 2	POWER	OFF
VS1	VOLTAGE SELECTOR	220-240 V

D403: MV12N



D601, 608-611: S34

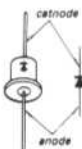

D801-804: U05G (U05E)

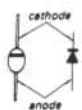

• Replacement Semiconductors

For replacement, use semiconductors except in ().

Q301, 351: 2SK58

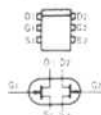

Q302, 352: 2SD668

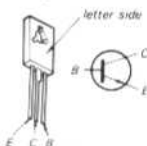

Q303, 353: 2SB648

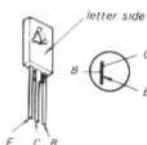

Q304, 307
Q313, 354
Q355, 363
Q402-404
Q406, 407 } : 2SC1364 (2SC634A)

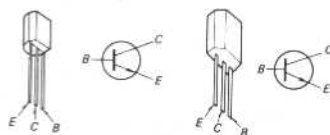

Q602, 604: 2SC1775F (2SC1810)

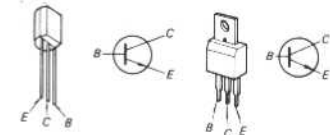

Q603: 2SA911

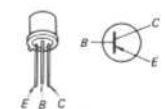

Q608: 2SC1775F (2SC1890)

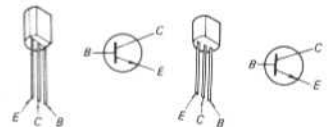

Q309, 359: 2SD667

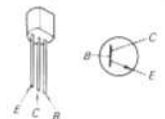

Q308, 358: 2SB647
Q607: 2SA639S (2SA893)

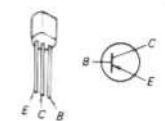

Q310, 360: 2SB655

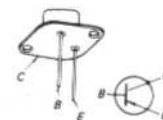

Q305, 306, 312
Q356, 357, 362
Q401, 405 } : 2SA678

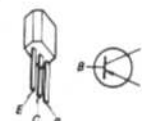

Q311, 361: 2SD675

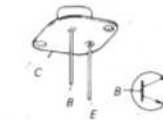

Q601, 613: 2SC2023-R
Q609-612: 2SC2023-R
2SC2023-O } (2SC2023)

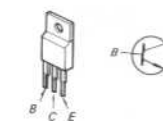

Q605, 606: 2SA678 (2SA844)

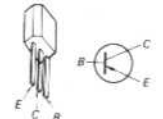

IC301, 351: CX171

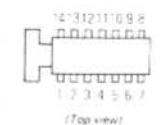

D301, 302, 351, 352
D402, 404, 603-605
D903, 953 } : 1S1555

D602: RD5.6E (RD5.6E-B)
D901, 902, 951, 952 } : 1T22AM (1T22)



D304, 305, 354, 355 } : EQB01-21 (EQA01-21R)

D401: EQB01-07 (EQA01-07)

